

SAFETY INFORMATION SHEET

WARNING

INSTALLATION OF THIS PRODUCT NEAR POWER LINES IS DANGEROUS. FOR YOUR SAFETY, FOLLOW THE ENCLOSED INSTALLATION DIRECTIONS.

HOW TO INSTALL YOUR OUTDOOR ANTENNA SAFELY IN ACCORDANCE WITH THE RECOMMENDATIONS OF THE U.S. CONSUMER PRODUCT SAFETY COMMISSION

These safety recommendations apply to all SIRIO commercial, amateur and general purpose communication antennas. SIRIO antenna assumes no liability if faulty or dangerous installation practices are used. There are available, trained and experienced personnel to assist in installation, maintenance, or disassembly. Contact your local installer if consultation or assistance is required.

YOU, YOUR ANTENNA, AND SAFETY

Each year hundreds of people are killed, mutilated or receive severe permanent injuries when attempting to install an antenna. In many of these cases, the victim was aware of the danger of electrocution, but did not take adequate steps to avoid the hazard.

For your safety, and to help you achieve a good installation, please **READ** and **FOLLOW** the safety precautions below. **THEY MAY SAVE YOUR LIFE!**

1. If you are installing an antenna for the first time, please, for your own safety as well as others, seek **PROFESSIONAL ASSISTANCE**. Consult your dealer. He can explain which mounting method to use for the size and type antenna you are about to install.
2. Select your Installation site with safety, as well as performance, in mind. (Detailed information on Site Selection appears in a separate section of this booklet.) **REMEMBER: ELECTRIC POWER LINES AND PHONE LINES LOOK ALIKE. FOR YOUR SAFETY, ASSUME THAT ANY OVERHEAD LINES CAN KILL YOU.**
3. Call your electric power company. Tell them your plans and ask them to come look at your proposed installation. This is a small inconvenience considering **YOUR LIFE IS AT STAKE**.
4. Plan your installation procedure carefully and completely before you begin. Successful raising of a mast or tower is largely a matter of coordination. Each person should be assigned to a specific task, and should know what to do and when to do it. One person should be designated as the "boss" of the operation to call out instructions and watch for signs of trouble.
5. When installing your antenna, **REMEMBER: DO NOT** use a metal ladder. **DO NOT** work on a wet or windy day. **DO** dress properly - shoes with rubber soles and heels, rubber gloves, long sleeve shirt or jacket.
6. If the assembly starts to drop, get away from it and let it fall. Remember, the antenna, mast, cable and metal guy wires are all excellent conductors of electrical current. Even the slightest touch of any of these parts to a power line complete an electrical path through the antenna and the installer - **THAT'S YOU!**
7. If any part of the antenna system should come in contact with a power line - **DON'T TOUCH IT OR TRY TO REMOVE IT YOURSELF. CALL YOUR LOCAL POWER COMPANY.** They will remove it safely.

If an accident should occur with the power lines call for qualified emergency help immediately.

SITE SELECTION

Before attempting to install your antenna, think where you can best place your antenna for **safety** and **performance**.

To determine a safe distance from wires, power lines and trees:

1. Measure the height of your antenna.
2. Add this length to the length of your tower or mast, and then
3. Double this total for the minimum recommended safe distance.

If you are unable to maintain this safe distance, **STOP! GET PROFESSIONAL HELP.** Many antennas are supported by pipe masts attached to the chimney, roof or side of the house. Generally, the higher the antenna is above the ground, the better it performs. Good practice is to install your antenna about 5 to 10 feet above the roof line and away from power lines and obstructions. Remember that FCC limits your antenna height to 60 feet. If possible, find a mounting place directly above your set, where the antenna wire can take a short, vertical drop on the outside of the house for entry through a wall or window near the set. Your dealer carries a complete line of installation hardware.

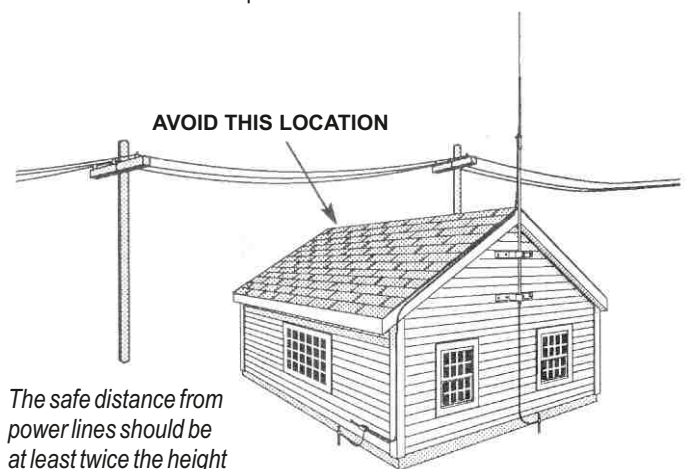

The safe distance from power lines should be at least twice the height of the antenna and mast combined.

CHOOSE A PROPER SUPPORT AND MOUNTING METHOD

However you decide to mount and support your antenna always make sure that safety is your first concern. Some of the more common installation methods are illustrated below.

ROOF MOUNTED

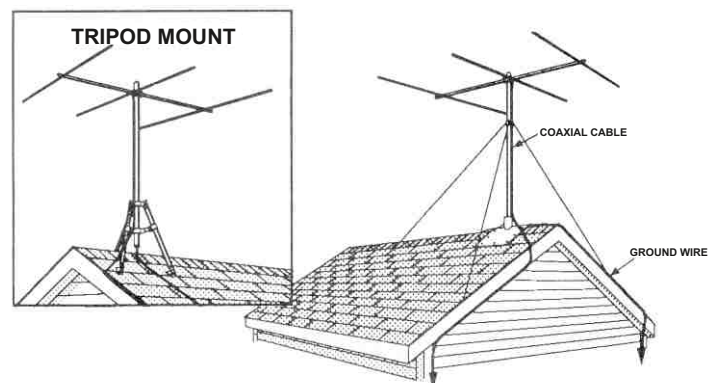

ROOF MOUNTING

The swivel feature of "universal" type mounting brackets makes a convenient antenna mount for flat or peaked roofs. One clamp type bracket is used with 3 or 4 guy wires equally spaced around the mast and anchored to the roof or eaves by eyebolts. Apply roofing compound around the base of the bracket, screws and eyebolts for moisture sealing.

TELESCOPING MAST

Guy wires should be equally spaced in at least three directions. Use at least three guy wires for each 10 foot section of mast.

SIDE OF HOUSE MOUNTING

The safe distance from power lines is at least twice the height of antenna and mast combined. Where roof overhang is not excessive, the side of the house provides a convenient mounting. Position the brackets over a stud if possible, one above the other, and space two or three feet apart. For metal siding, first mark mounting holes, then drill pilot holes through the siding to accept mounting screws.

TOWER

Tower safety is paramount to a good installation and requires that you take location, tree growth, soil depth and proximity to buildings into consideration. Tower foundations must be securely based on a solid concrete/ tower mounting plate. An alternative is to sink a 4-6 foot section of tower into a concrete base for an extremely rugged mount. Proper guying is essential to a safe weather-resistant installation that must handle severe wind loading and is best accomplished with preformed guy grips, torque brackets and turnbuckles. When working on towers always use a safety belt made of high quality web-type material

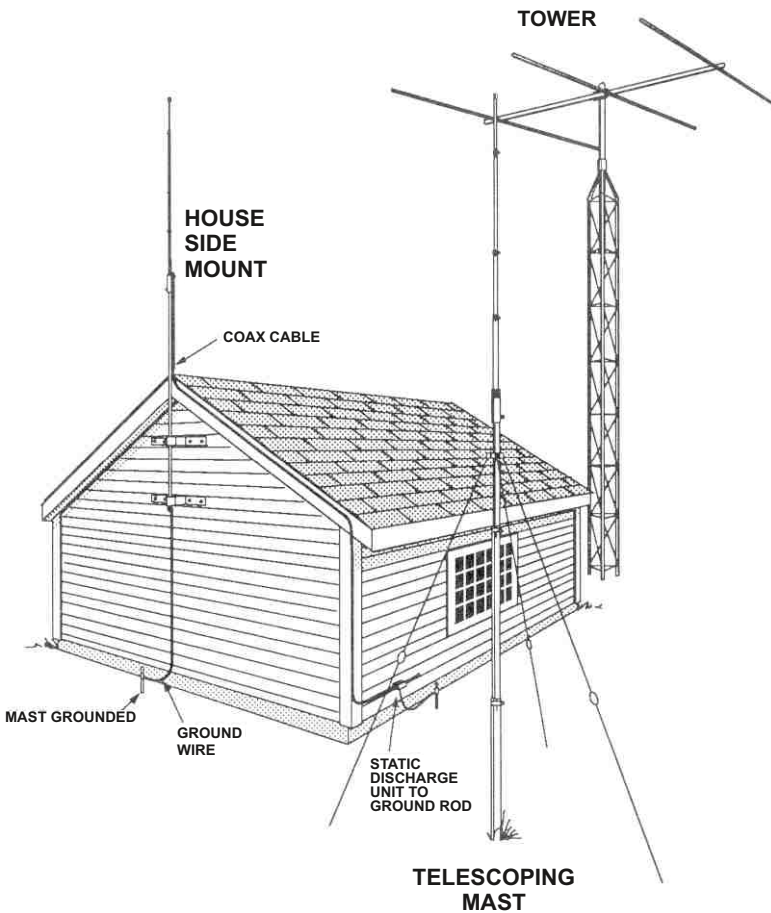

CHIMNEY MOUNTING

The chimney is often an easy and convenient mounting place. But the chimney must be strong enough to support the antenna in high winds. Do not use a chimney that has loose bricks or mortar. A good chimney mount makes use of a 5 or 10 foot, 1-1/4" diameter steel mast, and a heavy duty two strap clamp-type bracket. Install the upper bracket just below the top course of bricks, and the lower bracket two or three feet below the upper bracket. For maximum strength, space the brackets as far apart as possible.

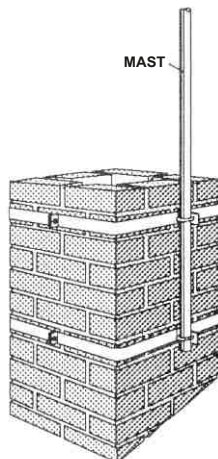

GENERAL INSTALLATION INSTRUCTIONS FOR MAST MOUNTED ANTENNAS

1. Assemble your new antenna on the ground at the installation site. Keep separate assembly instructions that come with it. Large CB and Amateur beams may have to be finally assembled on the tower or mast.
2. On the ground, clamp the antenna to mast and connect the coax cable to the antenna.
3. To insure that the mast does not fall the "wrong way" if it should get away during the installation or takedown, durable non-conductive rope should be secured at each two foot level as the mast is raised. The boss stands in a position where he can yank or pull the ropes if the need arise to deflect the falling mast away from hazards (such as power lines) into a "safe fall" (such as a yard or driveway). The ropes are tied taut at the base of the mast after installation and in place at the various levels.
4. Install selected mounting bracket.
5. If you are going to use guy wire installation instead of a mounting bracket:
 - install guy anchor bolts
 - estimate length of guy wire and cut
 - attach a mast using guy ring
6. Carefully take antenna and mast assembly to mounting bracket and insert. Tighten camp bolts. In case of guyed installation, it will be necessary to have at least a second person hold the mast upright while the guy wires are attached and tightened to the anchor bolts.
7. Install self-adhering "DANGER" label packaged in antenna hardware kit at eye level on your mast.
8. Install ground rod to drain off static electricity build-up and connect ground wire to mast and ground rod. Use special ground rods, not a spare piece of pipe.

EXAMPLE OF ANTENNA GROUNDING AS PER NATIONAL ELECTRICAL CODE INSTRUCTIONS

1. Use No. 10 AWG copper or No. 8 AWG or larger copper-clad steel or bronze wire, as ground wires for both mast and lead-in. Securely clamp the wire to the bottom of the mast.
2. Secure lead-in wire from antenna to antenna discharge unit and mast ground wire to house with stand-off insulators spaced from 4 feet (1.2 meters) to 6 feet (1.8 meters) apart.
3. Mount antenna discharge unit as close as possible to where the lead-in wire enters the house.
4. Drill a hole in wall (CAREFUL! There are wires in that wall.) near your set just large enough to permit entry of cable.
5. Push cable through hole and form a rain drip loop close to where it enters the house.
6. Put small amount of caulking around cable where it enters house to keep out drafts.
7. Install static electricity discharge unit.
8. Connect antenna cable to the set.

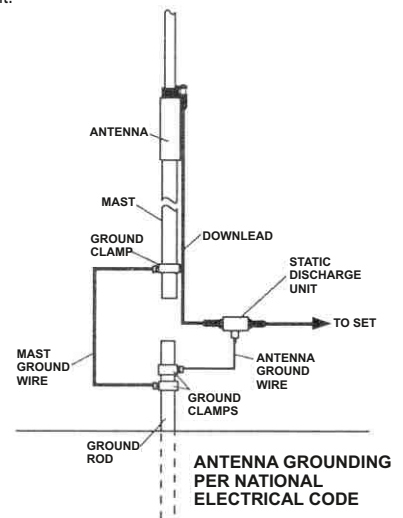

You should not attempt to raise a mast in excess of 30 feet in height/length (not including the antenna proper) in a fully-extended condition. Thirty to fifty foot tubular masts must be elevated, a section at a time, with the base or outer section secured in place with guy wires.

GET PROFESSIONAL HELP.

IT FOGLIO INFORMATIVO DI SICUREZZA

ATTENZIONE

L'INSTALLAZIONE DI QUESTO PRODOTTO VICINO ALLE LINEE DELL'ALTA TENSIONE E' PERICOLOSA. SEGUIRE LE ISTRUZIONI PER LA VOSTRA SICUREZZA

SIRIO antenna non si assume alcuna responsabilità se si utilizzano pratiche di installazione pericolose. E' disponibile personale qualificato e con esperienza per assistervi nell'installazione, manutenzione, o lo smontaggio. Contattate il vostro installatore locale per richiedere una consulenza o assistenza.

1. Se state installando un'antenna per la prima volta, richiedete un'ASSISTENZA PROFESSIONALE. Consultate il vostro rivenditore che saprà spiegarvi il metodo più idoneo e sicuro per montare il tipo di antenna che volete utilizzare.
2. Scegliete il luogo più sicuro per l'installazione. La distanza di sicurezza dalle linee dell'alta tensione deve essere almeno due volte l'altezza dell'antenna con il palo. **RICORDATE: LE LINEE DELL'ALTA TENSIONE E LE LINEE TELEFONICHE SONO SIMILI PERTANTO STATE LONTANO DA QUALSIASI LINEA DI TENSIONE. POTREBBE UCCIDervi !!** Quando installate la vostra antenna, **RICORDATE:**
 - a) **NON USATE** scale di metallo;
 - b) **NON LAVORATE** in un giorno di vento o di pioggia;
 - c) **UTILIZZATE** un abbigliamento appropriato (scarpe con suola in gomma, guanti in gomma, maglia con manica lunga)
3. Se il vostro impianto inizia a cedere, allontanatevi e lasciatelo cadere. Ricordate che l'antenna, il palo, il cavo e i fili di metallo sono ottimi conduttori di elettricità. Anche il contatto più lieve di una di queste parti alle linee dell'alta tensione provoca un collegamento elettrico dalla linea all'installatore attraverso l'antenna.
4. Se una qualsiasi parte dell'antenna dovesse entrare in contatto con una linea di elettricità, **NON TOCCATELA**. Chiamate gli operatori della società elettrica, sapranno rimuoverla in modo sicuro e corretto.

ISTRUZIONI GENERALI

1. Seguire attentamente le istruzioni di montaggio sul foglio illustrativo allegato al prodotto.
2. Collegare il palo di sostegno a terra utilizzando una trecciola in rame con una sezione di almeno 6 mm².
3. Assicurarvi del corretto serraggio di dadi e viti.
4. Se necessario (zone molto ventose o palo di sostegno molto lungo) si consiglia l'utilizzo di tiranti di controventatura.
5. **NON SOSTARE** vicino all'antenna mentre sta trasmettendo.
6. Si consiglia di rispettare sempre la potenza massima stabilita dalle norme vigenti
7. Attaccare sul palo di sostegno l'etichetta autoadesiva "PERICOLO" contenuta nella confezione in posizione visibile (altezza occhi).

FR FICHE D'INFORMATION SUR LA SÉCURITÉ

ATTENTION

L'INSTALLATION DE CE PRODUIT PRES DE LIGNES A HAUTE TENSION EST DANGEREUSE. POUR VOTRE SECURITE, SUIVEZ LES INDICATIONS JOINTES

SIRIO antenna n'assume aucune responsabilité en cas d'installation défectueuse ou dangereuse. Il ya du personnel disponible, compétent et expérimenté pour aider à l'installation, l'entretien ou le démontage. Contactez votre installateur local si une consultation ou une assistance est requise.

1. Si vous installez une antenne pour la première fois, pour votre sécurité, faites appel à l'ASSISTANCE PROFESSIONNELLE. Consultez votre revendeur qui pourra vous expliquer quelle méthode de montage utiliser pour la taille et le type d'antenne que vous souhaitez monter.
2. Choisir un endroit d'installation sûr, la distance de sécurité des lignes à hautes tensions doit être au moins deux fois la hauteur de l'antenne et du mât. **RAPPEL: LES LIGNES A HAUTE TENSION ET LES LIGNES TELEPHONIQUES SE RESSEMBLENT. POUR VOTRE SECURITE, VERIFIER QU'AUUCUNE LIGNE NE PUISSE VOUS TUER.** Quand vous installez votre antenne, **REPPELEZ-VOUS:**
 - a) **NE PAS** utiliser d'échelle métallique,
 - b) **NE PAS** travailler un jour humide ou venteux,
 - c) **ETRE BIEN HABILILE** (chaussures et talons en caoutchouc, gants en caoutchouc, chemise à manches longues ou veste).
3. Si l'assemblage commence à tomber, s'en éloigner et le laisser tomber. Rappelez vous que l'antenne, le mât, le câble et les fils de fer sont d'excellents

conducteurs de courant électrique. Même le plus léger contact d'une de ces pièces avec une ligne à haute tension peut créer un contact électrique à travers l'antenne et l'installateur.

4. Si l'une des parties de l'antenne vient à être en contact avec une ligne à haute tension, **NE RIEN TOUCHER, NE PAS ESSAYER DE DEMOTER VOUS MEME, APPELZ VOTRE AGENCE D'ELECTRICITE** qui démontera l'antenne avec précaution.

INSTRUCTIONS GENERALES pour antennes avec mâts:

1. Suivre avec attention les instructions de montage du produit.
2. Brancher votre mât à la masse en utilisant un fil de cuivre d'une section minimale de 6 mm².
3. Faire attention au bon serrage des écrous et vis.
4. Si nécessaire (endroits venteux ou mât très longs) l'utilisation de haubans est recommandée.
5. Quand votre antenne est en mode TX (transmission) **NE PAS** rester à côté.
6. Il est recommandé de respecter strictement la puissance maximale établie par la loi.
7. Coller l'étiquette autocollante «ATTENTION» jointe à l'antenne sur votre mât à hauteur des yeux.

DE SICHERHEITS-INFORMATIONSBLETT

WARNUNG

DIE INSTALLATION DIESES PRODUKTS IN DER NÄHE VON STROMLEITUNGEN IST GEFÄHRLICH. BEFOLGEN SIE ZU IHRER SICHERHEIT DIE FOLGENDEN ANWEISUNGEN.

SIRIO Antenne übernimmt keine Haftung, wenn fehlerhafte oder gefährliche Installationspraktiken angewandt werden. Es steht geschultes und erfahrenes Personal zur Verfügung, um Sie bei der Installation, Wartung oder Demontage zu unterstützen. Kontaktieren Sie Ihren Fachhändler, wenn Beratung oder Unterstützung erforderlich ist

1. Wenn Sie zum ersten Mal eine Antenne installieren, sollten Sie sich von Ihrem Fachhändler beraten lassen. Er kann Ihnen erklären, welche Montagemethode für die Größe und den Typ der Antenne, die Sie montieren wollen, zu verwenden ist.
 2. Wählen Sie Ihren Installationsort unter dem Gesichtspunkt der Sicherheit aus. Der Sicherheitsabstand von Stromleitungen sollte mindestens das Doppelte der gemeinsamen Länge von Antenne und Mast betragen. **OFT KÖNNEN SIE ALS LAIE ELEKTRISCHE STROMLEITUNGEN UND TELEFONLEITUNGEN NICHT UNTERSCHIEDEN. - GEHEN SIE ZU IHRER EIGENEN SICHERHEIT ZUNÄCHST EINMAL DAVON AUS, DASS JEDLICHE LUFTLEITUNGEN SIE TÖTEN KÖNNTE !!** Wenn Sie Ihre Antenne installieren, **DENKEN SIE DARAN:**
 - a) **Verwenden sie keine Metall-Leiter.**
 - b) **Führen sie diese Arbeiten, wenn möglich, nicht an regnerischen oder stürmischen Tagen aus.**
 - c) **Achten sie auf richtige Kleidung:** (Schuhe mit Gummisohlen und -absätzen, Gummihandschuhe, Hemd bzw. Jacke mit langen Armen).
 3. Sollte bei der Montage Antenne oder Mast aus irgendwelchen Gründen hinfallen, sollten Sie diese in diesem Moment nicht mehr berühren. Denken Sie daran, daß Antenne, Mast, Kabel und metallische Verankerungsdrähte ausgezeichnete Leiter von elektrischen Strom sind. Selbst die leichteste Berührung dieser Teile mit einer Stromleitung erzeugt einen elektrischen Stromkreis und kann Sie sofort töten.
 4. Wenn irgendein Teil des Antennensystems mit einer Stromleitung in Kontakt kommen sollte, **BERÜHREN SIE ES NICHT UND VERSUCHEN SIE NICHT, ES SELBST ZU ENTFERNEN. RUFEN SIE IHRE ÖRTLICHE ELEKTRIZITÄTSGESELLSCHAFT AN.** Die Fachleute dieser Gesellschaften werden das Problem sicher und gefahrlos lösen.
- ALLGEMEINE MONTAGEANWEISUNGEN FÜR ANTENNEN, DIE AUF EINEM MAST MONTIERT SIND:**
1. Befolgen Sie sorgfältig die Montageanweisungen des Produkts.
 2. Verbinden Sie Ihren Mast mit einem guten Erdungspotential, indem Sie einen Kupferdraht mit einem Querschnitt von mindestens 6 mm² verwenden.
 3. Achten Sie auf den korrekten Sitz von Muttern und Schrauben.
 4. Wenn notwendig (Gegenden mit häufigen starken Winden bzw. Stürmen oder sehr hohe Masten) wird die Verwendung von speziellen Abspannseilen (Erhältlich im guten Fachhandel) empfohlen.
 5. **Halten Sie sich nicht** in der Nähe Ihrer Antenne auf, während Ihr Funkgerät im Sendemodus ist.
 6. Es wird empfohlen, die gesetzlich festgelegte maximale Leistung des Funkgerätes nicht zu überschreiten.
 7. Kleben Sie das der Antenne beiliegende selbstklebende Etikett "ACHTUNG" in Augenhöhe an Ihren Mast.

ES HOJA DE INFORMACIÓN DE SEGURIDAD

ATENCIÓN

LA INSTALACIÓN DE ESTE PRODUCTO CERCANO A UNA LÍNEA DE ALTA TENSIÓN PUEDE SER PELIGROSO. SIGA ATENTAMENTE LAS INSTRUCCIONES PARA SU SEGURIDAD.

SIRIO Antenne no asume ninguna responsabilidad si se efectúan acciones irresponsables o peligrosas en el momento de la instalación. Hay personal disponible, capacitado y con la experiencia necesaria para ayudar o realizar el mantenimiento, montaje y desmontaje. Póngase en contacto con su instalador local si precisa asesoramiento o asistencia.

1. Si usted pretende instalar una antena por primera vez, déjese aconsejar por un profesional, consulte en su establecimiento habitual y siga todas sus recomendaciones.
2. Elija el lugar más seguro para la instalación. La distancia de seguridad con respecto a la línea de alta tensión, deberá ser al menos dos veces la altura de la antena, una vez instalada en el mástil. **RECUERDE: LAS LÍNEAS DE ALTA TENSIÓN Y LAS LÍNEAS TELEFÓNICAS SON PARECIDAS. PARA SU SEGURIDAD MANTENGASE ALEJADO DE ELLAS.** Cuando instale la antena, **RECUERDE:**
 - a) **NUNCA** utilice una escalera metálica
 - b) **NO pretenda instalar la antena** en un día con viento, lluvia o nieve.
 - c) **UTILICE** ropa y material adecuado (zapatos aislantes con suela de goma, guantes de goma, camisa de manga larga)
3. Si la instalación no está bien efectuada, ésta podría caer, ocasionar grandes desperfectos e incluso causando daños a terceros. Le recomendamos proceda con extrema precaución.
4. Si una parte de la antena entrara en contacto con algún cable eléctrico **ALEJESE INMEDIATAMENTE.** Llame urgentemente a la compañía eléctrica, **NO intente resolver por su cuenta el incidente.** Ellos sabrán solucionar el problema de un modo correcto y seguro.

INSTRUCCIONES GENERALES

1. Siga atentamente las instrucciones de la hoja ilustrativa que acompaña al producto.
2. Si tiene alguna duda **NO prosiga con la instalación.** Consulte personal cualificado
3. Derive a tierra el mástil de sujeción mediante un cable de 6mm². de sección mínimo.
4. Verifique que los tornillos y tuercas han sido debidamente fijados.
5. Si es necesario (zonas de mucho viento o mástiles muy largos) utilice tirantes de vientos.
6. **NO PERMANEZCA** cerca de la antena mientras se está transmitiendo.
7. Se aconseja siempre respetar la potencia máxima establecida por las normas vigentes
8. Coloque en el mástil la etiqueta autoadhesiva "PELIGRO" suministrada con la antena, situada en un lugar lo suficientemente visible. (Altura de la vista)

PL KARTA INFORMACJI BEZPIECZEŃSTWA

UWAGA

INSTALOWANIE ANTEN W POBLIŻU LINII WYSOKIEGO NAPIĘCIA JEST NIEBEZPIECZNE!

SIRIO Antene nie ponosi żadnej odpowiedzialności w razie awarii instalacji w wyniku błędnego zamontowania lub stosowanych niebezpiecznych praktyk. W przypadku problemów podczas montażu należy skontaktować się z przeszkolonym i doświadczonym personelem jak i w celu konserwacji czy demontażu.

1. Montując antenę po raz pierwszy, dla własnego bezpieczeństwa, poproś o pomoc specjalistów.
2. Wybierz starannie miejsce montażu w odległości minimum 2 długości anteny plus masztu od linii energetycznej. Nie używaj metalowej drabiny, załóż buty z gumową podeszwą, rękawiczki, koszulę z długim rękawem i nie pracuj w złych warunkach pogodowych.
3. Jeżeli montowana konstrukcja zaczyna się przewracać nie podtrzymuj jej.
4. Jeżeli część instalacji już dotknęła kabli z prądem nie usuwaj jej sam tylko zadzwoń od zakładu energetycznego.

Podstawowe instrukcje:

1. Zapoznaj się z instrukcją produktu.
2. Uziemij maszt przewodem min. 6 mm².
3. Starannie skręcaj połączenia.
4. Używaj odpornych na wiatr elementów masztu.
5. Nie przebywaj w pobliżu anteny podczas nadawania.
6. Nie przekraczaj limitów mocy.
7. Oznacz instalację ostrzegawczą nalepką «UWAGA».

RU информация о безопасности

ВНИМАНИЕ

установка данного устройства возле высоковольтных линий электропередачи опасна для жизни! Следуйте прилагаемой инструкции!

SIRIO Antenne не несет никакой ответственности за неисправности, произошедшие в результате неправильного монтажа. Привлекайте обученный и опытный персонал для оказания помощи в установке, техническом обслуживании, сборке или разборке. Свяжитесь с вашим местным установщиком для консультации или помощи, в случае необходимости.

1. Если Вы устанавливаете антенну в первый раз, найдите профессионального помощника. Ваш дилер может объяснить Вам способ установки антенны в зависимости от типа и размера антенны.
2. Тщательно выбирайте место установки. Расстояние до высоковольтной ЛЭП должно, как минимум, дважды превышать высоту мачты и антенны. **ПОМНИТЕ: высоковольтные ЛЭП, а также телефонные и другие кабельные линии находятся под напряжением, которое опасно для жизни!** Во время установки антенны **ПОМНИТЕ:**
 - a) не используйте металлическую лестницу;
 - б) не работайте во влажную и ветряную погоду;
 - в) наденьте рубашку или куртку с длинными рукавами, обувь на резиновой подошве, а также используйте резиновые перчатки.
3. Если собираемая часть начинает падать немедленно отойдите в сторону и не препятствуйте падению. Помните, что антенна, мачта, кабель и металлические провода являются проводниками электрического тока. Даже легкое касание любой из составных частей антенной системы к открытому источнику электроэнергии может привести к короткому замыканию или поражению электрическим током.
4. Если одна из частей устанавливаемой антенной системы в результате падения или по другой причине соприкоснулась с источником электроэнергии, **НЕ ПЫТАЙТЕСЬ САМОСТОЯТЕЛЬНО УСТРАНИТЬ ЭТО, ПОЗВОНИТЕ В АВАРИЙНУЮ СЛУЖБУ!**

ОСНОВНЫЕ ИНСТРУКЦИИ ПО УСТАНОВКЕ АНТЕННЫ НА МАЧТУ

1. Внимательно следуйте инструкции по установке антенны.
2. Заземлите мачту медным проводом с сечением не менее 6 кв. мм.
3. Установите антенну, обращая внимание на правильность сборки и надежность затяжки болтов и гаек.
4. Если необходимо (районы с повышенными ветряными нагрузками или слишком длинная мачта) используйте специальные противоветровые направляющие.
5. Не находите вблизи антенны во время передачи.
6. Рекомендуется использовать максимально разрешенную мощность передачи в соответствии с законодательством.
7. Наклейте этикетку "ОПАСНО" упакованную вместе с антенной на мачту, на уровне глаз

CZ BEZPEČNOSTNÍ INFORMACNÍ LIST.

VAROVANI

NEMANIPULUJTE S ANTENOU POBLIŽ ELEKTRICKEHO VEDENÍ!

SIRIO nepřebírá žádnou zodpovědnost v případě neodborné či nebezpečné montáže. Montáž, údržbu nebo demontáž svěřte kvalifikovanému odbornému servisu.

1. Pokud nemáte s montáží zkušenosti, použijte odbornou firmu
2. Používejte ochranný oblek
3. Při instalaci do anteny nevysilejte
4. Při jakémkoli kontaktu s elektrickým vedením informujte rozvodné závody

Zakladni instrukce:

1. Pozorne čtete montážni navod
2. Antenni stožar uzemnete vodičem 6mm²
3. Zvýšenou pozornost venujte kontaktům a spojům
4. Nemontujte antenu v extrémne nepriznivem počasí
5. Při vysílání se nedotýkejte zariče
6. Nepoužívejte vyší výkon než je výrobcem určeno
7. Antenu označte štítkem "NEBEZPEČÍ!"

TUNING INSTRUCTIONS

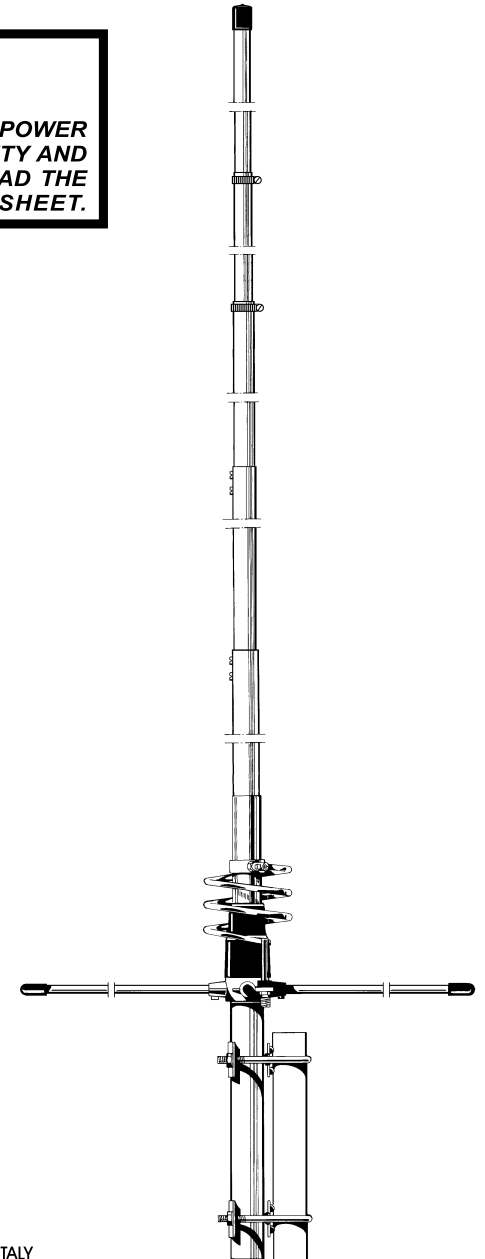
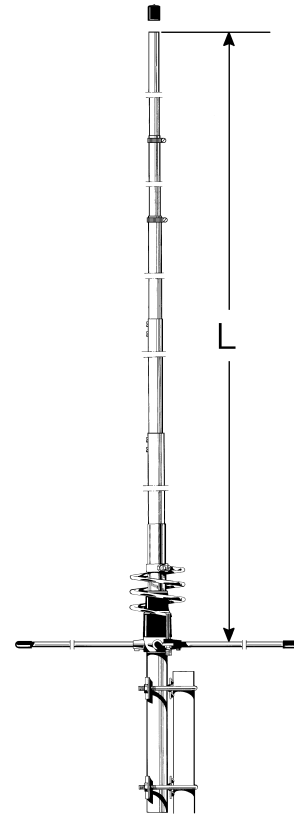
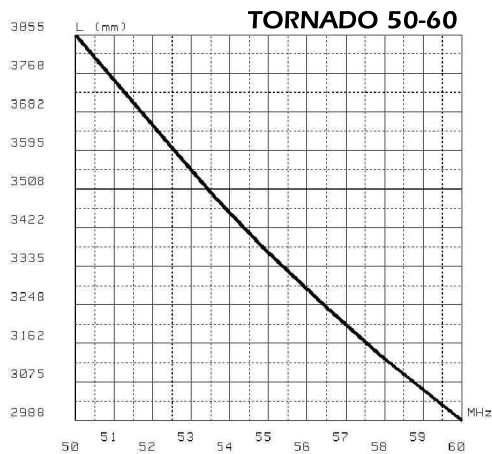
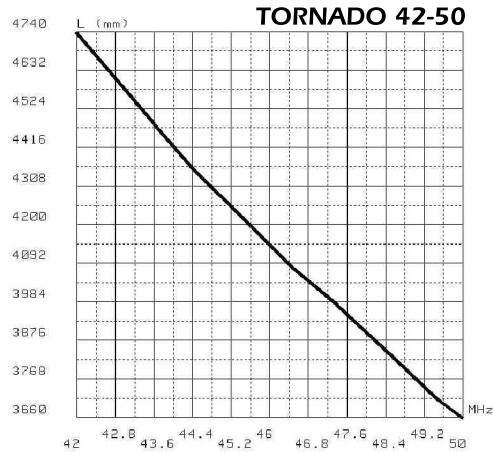
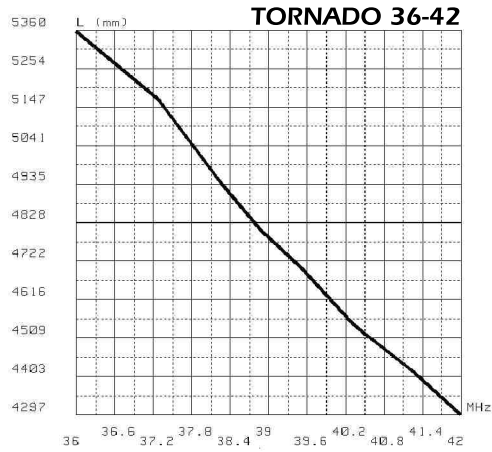

TORNADO Series

36...60MHz VHF Base Station Antennas

WARNING

INSTALLATION OF THIS PRODUCT NEAR POWER LINES IS DANGEROUS. FOR YOUR SAFETY AND BEFORE YOU BEGIN INSTALLATION, READ THE SEPARATE SAFETY INFORMATION SHEET.

NOTE:

- **L** is the height from the ground plane
- It is recommended to use the curves as a guide. Fine-tuning by using an SWR-Meter.



HI-QUALITY ANTENNAS MADE IN ITALY



HI-QUALITY ANTENNAS MADE IN ITALY

SPECIFICATIONS

Electrical Data	TORNADO 36-42	TORNADO 42-50	TORNADO 50-60
Type	5/8 λ Ground Plane		
Frequency Range	tunable 36...42 MHz	tunable 42...50 MHz	tunable 50...60 MHz
Impedance	50 Ω		
Radiation (H-plane)	360° Omnidirectional		
Polarization	Linear Vertical		
Gain	1.2 dBd - 3.35 dBi		
SWR @ res. freq.	≤ 1.2 @ 36 MHz	≤ 1.2 @ 42 MHz	≤ 1.2 @ 50 MHz
Bandwidth @ SWR ≤ 2	≥ 2.2 MHz @ 36 MHz	≥ 2.4 MHz @ 42 MHz	≥ 3.1 MHz @ 50 MHz
Max Power (CW) @30°C	1000 Watts		
Connector	UHF-female		
Mechanical Data			
Materials	Aluminium, Nylon, Brass		
Wind Load @ 150 km/h	178 N	167 N	138 N
Wind Resistance	150 Km/h		
Wind Surface	0.15 m ²	0.14 m ²	0.12 m ²
Height (approx.)	5650 mm	5010 mm	4100 mm
Weight (approx.)	2250 gr		
Radial Length (approx.)	1170 mm		
Mounting Mast	∅ 35 - 42 mm		
P/N	2108601.00	2107801.00	2108901.00

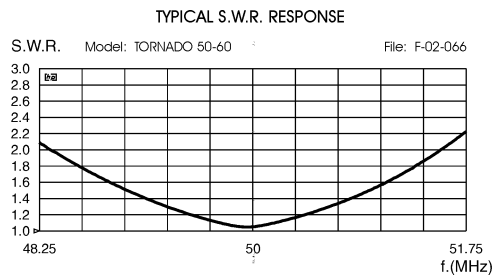
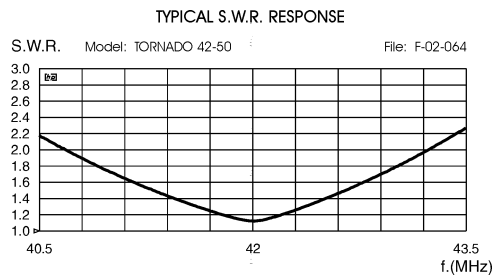
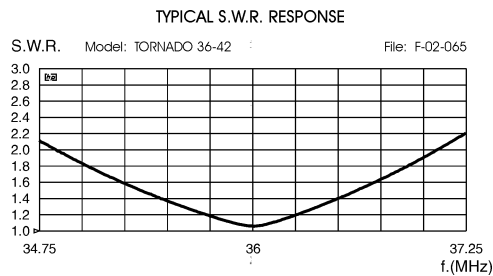

HI-QUALITY ANTENNAS MADE IN ITALY

MOUNTING INSTRUCTIONS

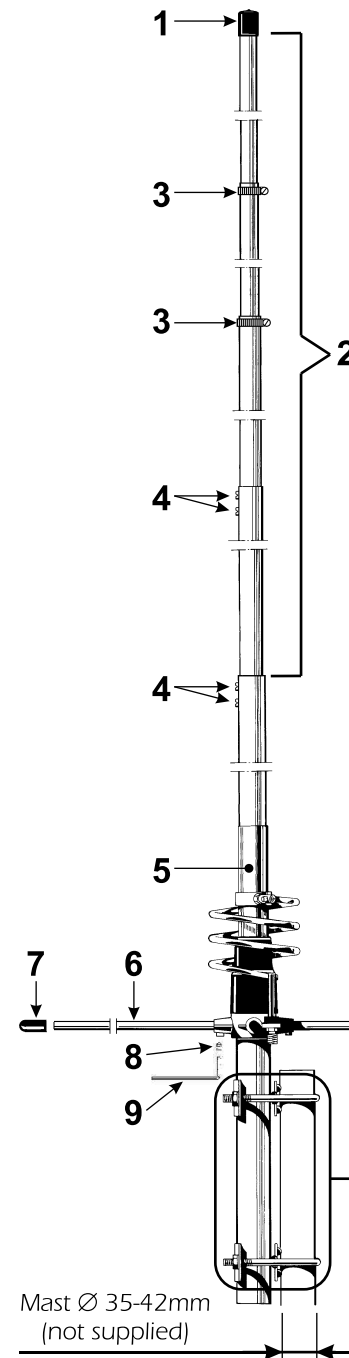

Parts List		
Pos	Q.ty	Description
1	1	PVC cap for top tube (specify frequency for replacement)
2	1	telescopic aluminium whip 5 section (TORNADO 36-42) 4 section (TORNADO 42-50) 3 section (TORNADO 50-60)
3	2	∅ 12-22 mm hose clamps (TORNADO 36-42, 42-50)
	1	(TORNADO 50-60)
4	6	∅ 3.9x12.7 mm phillips tapping screws (TORNADO 36-42)
	4	(TORNADO 42-50, 50-60)
5	1	Bottom section assembled with coil and connector (specify frequency for replacement)
6	4	∅ 6x8x1170mm radials aluminium tubes
7	4	PVC cap for ∅ 8mm aluminium tubes
8	4	M6x6 hexagon socket set screw cup point
9	1	3 mm hexagonal key
10	4	M6 washers
11	4	M6 spring lock washers
12	4	M6 hexagonal nuts
13	2	30x65mm steel V bracket
14	2	30x65mm steel flat bracket
15	2	M6x240 mm U-bolts

Mounting needed tools:

- n. 1 tape rules (meter)
- n. 1 phillips screwdriver
- n. 1 10 mm open key

REMARK: use a good coax cable like RG-8 or RG-213 as short as possible to get the best performance and we recommend to mount your antenna as far as possible from metal roofs, walls, power lines and other antennas.

